

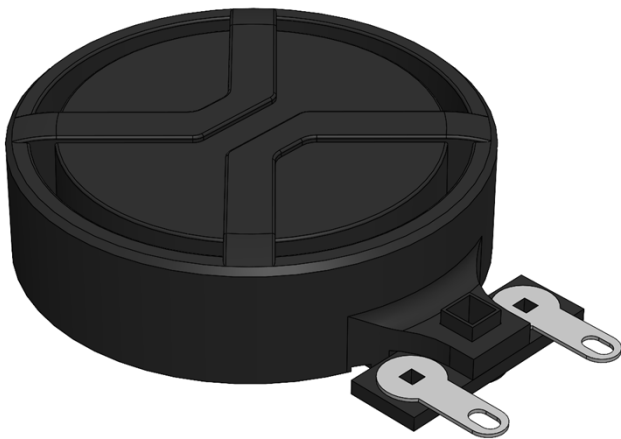

XTREME SERIES

Xtreme Audio Performance
at an Unbeatable Price!

XT19-8 SPECIFICATIONS



- > Xtreme Slim Design
- > Xtreme Powerful with 4-Layer Voice Coil
- > Xtreme Wide Frequency Response
- > Xtreme Low Distortion
- > Designed in Germany

XT19-8 SPECIFICATIONS

Electrical and Mechanical Properties

Rms Noise Test [W]	10
Long-term Max Power [W]	20
Frequency Range [Hz] ¹	75Hz – 20kHz
Nominal Impedance [Ohm]	8
DC Resistance [Ohm]	7.39
Le [mH] Re2 [Ohm] Le2 [mH]	0.11 3.54 0.07
Kms [N/mm]	7.22
Cms [mm/N]	0.14
Bl [N/A]	3.24
Motor Efficiency Factor β [dB] ²	1.52
Linear Xmax - IEC 60268 [mm]	± 1.0
Mechanical Xmax [mm]	± 2.4

Position Related Properties ³	Magnet	Coil
Fs [Hz]	79.3	473
Mms [g]	29.1	0.82
Rms [Kg/s]	0.64	0.07
Qts	7.03	1.97
Qms	22.5	17.9
Qes	10.2	2.22

Physical Properties

Total Weight [g]	29.9
Outer Diameter [mm]	36.3
Total Height [mm]	14.0
Voice Coil Diameter [mm]	19
Voice Coil Layers	4

- (1) The final frequency range is dependent on the panel properties
 (2) $10\log(\beta)$ with $\beta = Bl^2/Re$ [ref: 1Kg/s]
 (3) Exciters have two degrees of freedom - TSP measured by fixing one
 * On-axis anechoic measurement 1m/2.83V [1/3rd octave smoothing]
 3mm acrylic panel with A=0.3m² and R=2 - fixed edges - open back
 XT19-8 positioned at 35% | 50% - converted from 4pi to 2pi (+6dB)

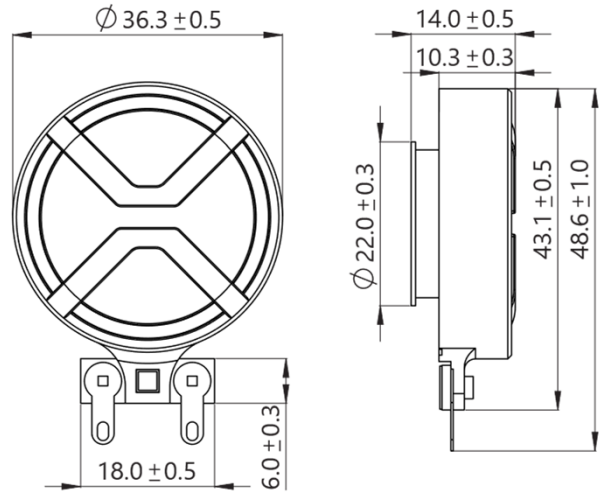

Distortion Relevant Properties

At higher amplitudes, exciters generate nonlinear distortions primarily from $Bl(x)$ and $Kms(x)$. The Xtreme Series is optimized to generate low harmonic and intermodulation distortions.

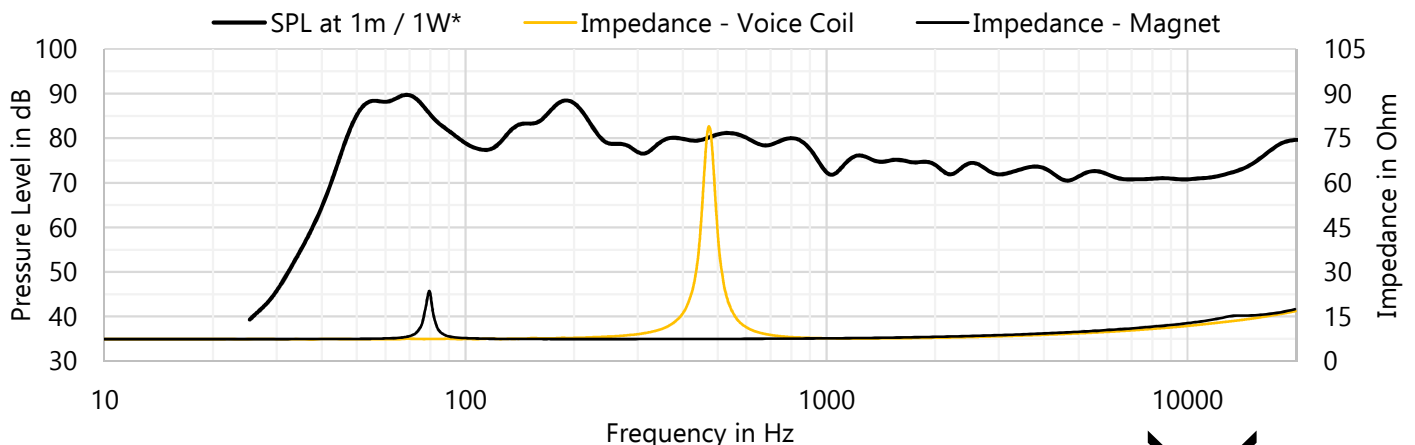
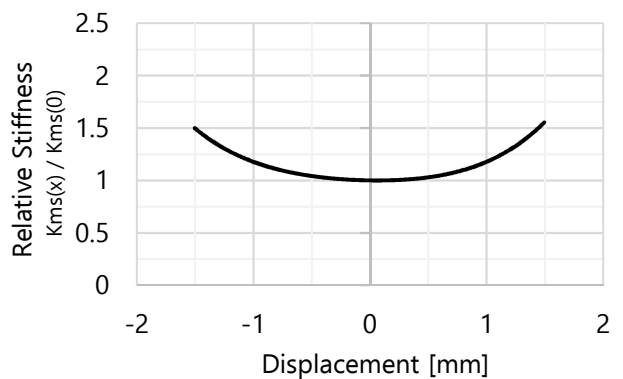
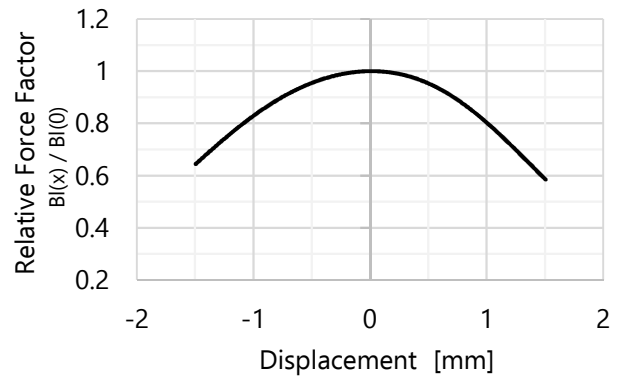

XTREME SERIES

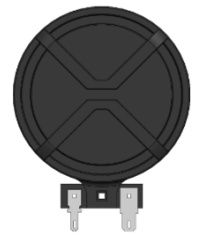

XT19-8

XT25-8

XT32-8

XTB40-8

	Xtreme Slim	Xtreme Highs	Xtreme All-round	Xtreme Bass
Long-term Max Power [W]	20	30	40	160
Frequency Range [Hz]	75Hz – 20kHz	40Hz – 19kHz	35Hz – 17kHz	25Hz – 1kHz
Fs Magnet [Hz]	79.3	45.8	39.3	29.9
Motor Efficiency Factor β [dB]*	1.52	4.68	6.28	13.8
Linear Xmax [mm]	± 1.0	± 1.4	± 1.6	± 2.5
Mechanical Xmax [mm]	± 2.4	± 3.0	± 3.5	± 5.0
Total Height [mm]	14.0	21.5	24.8	31.0
Outer Diameter [mm]	36.3	46.8	54.5	65.0
Total Weight [g]	29.9	76.3	133	319

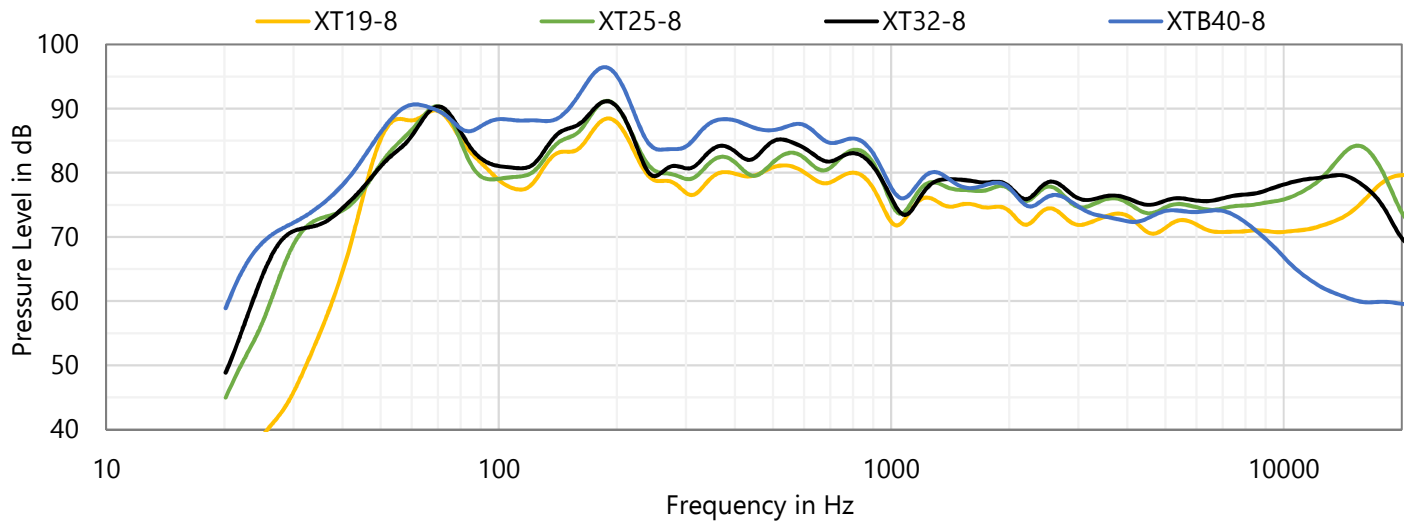

h=14.0mm



h=21.5mm



h=24.8mm



h=31.0mm



d=36.3mm



d=46.8mm



d=54.5mm



d=65.0mm